

Experimental information complementarity of two-qubit states

A Fedrizzi^{1,3}, B Škerlak¹, T Paterek², M P de Almeida¹
and A G White¹

¹ ARC Centre for Engineered Quantum Systems and ARC Centre for Quantum Computer and Communication Technology, School of Mathematics and Physics, University of Queensland, Brisbane 4072, Australia

² Centre for Quantum Technologies, National University of Singapore,

3 Science Drive 2, 117542 Singapore, Singapore

E-mail: a.fedrizzi@uq.edu.au

New Journal of Physics **13** (2011) 053038 (11pp)

Received 21 October 2010

Published 20 May 2011

Online at <http://www.njp.org/>

doi:10.1088/1367-2630/13/5/053038

Abstract. The concept of information offers a more complete description of complementarity than the traditional approach based on observables. We present the first experimental test of information complementarity for two-qubit pure states, achieving close agreement with theory. We also explore the distribution of information in a comprehensive range of mixed states. Our results highlight the strange and subtle properties of even the simplest quantum systems; for example, entanglement can be increased by reducing the correlations between two subsystems.

Complementarity reveals trade-offs between knowledge of physical observables. The best-known example is wave–particle duality: a single quantum system may exhibit wave and/or particle properties, depending on the experimental context. For a system in a two-mode interferometer, this is quantitatively expressed by the fact that the interference visibility \mathcal{V} and the mode predictability \mathcal{P} have to satisfy [1, 2]

$$\mathcal{V}^2 + \mathcal{P}^2 \leq 1. \quad (1)$$

High-quality interference comes at the expense of the impossibility of predicting the path of the system and vice versa, a phenomenon that has been demonstrated in a host of physical systems [3–8]. Relation (1) equals unity only in the case of pure, single-particle, quantum states. For mixed states, the left-hand side is always less than one and can even reach zero [3], which means that there is no knowledge about whether the system behaves as a particle or a wave.

³ Author to whom any correspondence should be addressed.

Table 1. The three families of quantum states we use to explore information complementarity: (i) pure states ρ_{PURE} ; (ii) highly entangled mixed states ρ_{WERNER} and ρ_{MEMS} (where $|\psi^-\rangle$, $|\phi^+\rangle$ are two of the four Bell states); and (iii) separable states ρ_{AS} , ρ_{S} . I_2 and I_4 are the one- and two-qubit identity matrices.

(i)	$\rho_{\text{PURE}} =$	$ \psi\rangle\langle\psi ; \psi\rangle = \cos\alpha 00\rangle + \sin\alpha 11\rangle$	$\alpha \in [0, \pi/4]$
(ii)	$\rho_{\text{WERNER}} =$	$p \psi^-\rangle\langle\psi^- + \frac{1-p}{4}I_4$	$p \in [0, 1]$
	$\rho_{\text{MEMS}} =$	$p \phi^+\rangle\langle\phi^+ + (1-p) 10\rangle\langle 10 $	$p \in [\frac{2}{3}, 1]$
		$0 \leq S(\rho) \lesssim 0.92$	
(iii)	$\rho_{\text{AS}} =$	$(p 0\rangle\langle 0 + \frac{1-p}{2}I_2) \otimes 0\rangle\langle 0 $	$p \in [0, 1]$
		$I_2/2 \otimes (q 0\rangle\langle 0 + \frac{1-q}{2}I_2)$	$0 \leq S(\rho) \leq 1$
			$q \in [0, 1]$
			$1 \leq S(\rho) \leq 2$
	$\rho_{\text{S}} =$	$p 00\rangle\langle 00 + \frac{1-p}{4}I_4$	$p \in [0, 1]$

This *knowledge deficit* for a single particle in a mixed state can be attributed to entanglement with a second particle. In addition to the *local* observables \mathcal{V} and \mathcal{P} , one therefore includes the *non-local* observable \mathcal{C} (which is the concurrence [9], a measure of entanglement) and finds that [10, 11]

$$(\mathcal{V}^2 + \mathcal{P}^2)_{\text{local}} + (\mathcal{C}^2)_{\text{corr}} \leq 1. \quad (2)$$

The complementarity is now between the *local* properties of an individual subsystem and its *correlations* with another subsystem. For pure two-particle states, relation (2) has been experimentally tested to some extent in [12, 13]—albeit in its early form of interferometric complementarity [14]. In [15], equation (2) has been measured for a ‘system’ qubit coupled to an ‘environment’ qubit via an amplitude damping channel. But again, in the case of mixed states, (2) does not saturate its bound. One could of course explain this as due to entanglement to yet another particle and so on, *ad infinitum*⁴. It would, however, be preferable to precisely identify the quantities involved in complementarity without resorting to virtual higher-dimensional Hilbert spaces.

Here we experimentally study a version of complementarity between two quantum bits that does not require infinite regression. It is phrased in terms of information and is symmetric and exact, i.e. all subsystems are treated on an equal footing and the relations are saturated also for mixed states. We experimentally test the complementarity for pure two-qubit states and explore the distribution of information in many interesting mixed states; see table 1. Finally, we show why traditional complementarity relations such as equation (2) cannot be exact for mixed states. They do not take into account correlations that are not captured by entanglement.

Information complementarity goes back to the insight that information is physical [18] and that the amount of information in a two-level quantum system (or *qubit*) is limited to 1 bit [19, 20]. Complementarity may now arise because there is insufficient information to simultaneously specify the results of different measurements that can be performed on a

⁴ This approach is in fact used to classify entanglement in multi-partite systems in [16].

quantum system. The single-particle complementarity relation (1) reflects this by being bounded to 1 (bit), a value that is saturated for a *pure* qubit. For a mixed state, the left-hand side of (1) is equal to a suitable measure of the reduced information content of the system [20].

This provides an alternative interpretation of the two-particle complementarity, equation (2). The total information content of two particles, I_{total} , can be split into information stored in subsystems, I_{local} , and a remaining part that we call the correlation information, I_{corr} , giving rise to the following relation [21]

$$I_{\text{local}} + I_{\text{corr}} = I_{\text{total}}, \quad (3)$$

which defines I_{corr} . The natural way to quantify the information of a given quantum state is to use its entropy. The information measure originally proposed in [20] is linked to the so-called *linear entropy* and, as we show in appendix A, equation (3) is equivalent to (2) for pure states. Note that (3) has the elegant feature of being symmetric with respect to subsystems, i.e. $I_{\text{local}} = I_a + I_b$, whereas the local observables \mathcal{V}^2 and \mathcal{P}^2 in (2) capture only one of the two subsystems. Their equivalence for pure states is a consequence of Schmidt decomposition according to which both subsystems are described by the same density operator. Unfortunately, for certain mixed two-particle states, the linear entropy measure leads to a *negative* I_{corr} ; see appendix A. We therefore adopt the *von Neumann* information $I(\rho) = \log_2 d - S(\rho)$, where $S(\rho) = -\text{Tr}(\rho \log_2 \rho)$ is the von Neumann entropy of a d -dimensional system described by the density matrix ρ , and we choose bits as the units of information content (N qubits carry at most N bits). The correlation information is then the *quantum mutual information*, $I_{\text{corr}} = I_{\text{total}} - I_{\text{local}} = S(\rho_a) + S(\rho_b) - S(\rho_{ab})$, which is non-negative for all physical states and is a measure for the total correlations present in a quantum state [22, 23].

Unlike traditional wave–particle duality, the information approach (3) has not been explored in any experimental system to date. We now investigate information complementarity for a range of two-photon quantum states. For pure two-qubit states, we can test complementarity relation (3), with its right-hand side bounded to $I_{\text{total}} = 2$; for mixed states, it will allow us to highlight the different types of correlations present in these systems. Our states can be grouped into three families (table 1): (i) ‘pure’ states, i.e. our best experimental approximation to pure; (ii) two classes of highly entangled mixed states—the Werner and maximally entangled mixed states [17, 24] (MEMS); and (iii) two classes of separable states. These states were chosen because—except for our particular choice of MEMS⁵—they represent the boundaries of the physical parameter space for two-qubit states in the tangle–entropy plane, figure 1.

The experimental scheme is depicted in figure 2. A source based on a polarization Sagnac loop [26, 27] produces two-photon states close to the ideal form $|\psi_{ab}\rangle = \cos \alpha |H_a H_b\rangle + \sin \alpha |V_a V_b\rangle$, where the logical qubit states ‘0’ and ‘1’ are encoded into the horizontal (H) and vertical (V) polarizations of the photons a and b . The degree of entanglement is determined by α , which is set by the pump laser polarization [26]. The resulting photons pass through two channels, \mathcal{E}_1 and \mathcal{E}_2 (figure 2). We perform both full single-qubit state tomography [28] on the individual photons a and b —from which we reconstruct ρ_a and ρ_b —and, separately, two-qubit tomography [28] on the two-photon state, which yields ρ_{ab} . These density matrices contain all information that one can possibly have about the underlying quantum states, and we can from them readily compute properties such as the tangle \mathcal{T} —the concurrence \mathcal{C} squared—or the

⁵ This particular MEMS was chosen over the rank-3 boundary MEMS [17] because it is well known, has a simple mathematical form and can be reached from an entangled state with local operations [25].

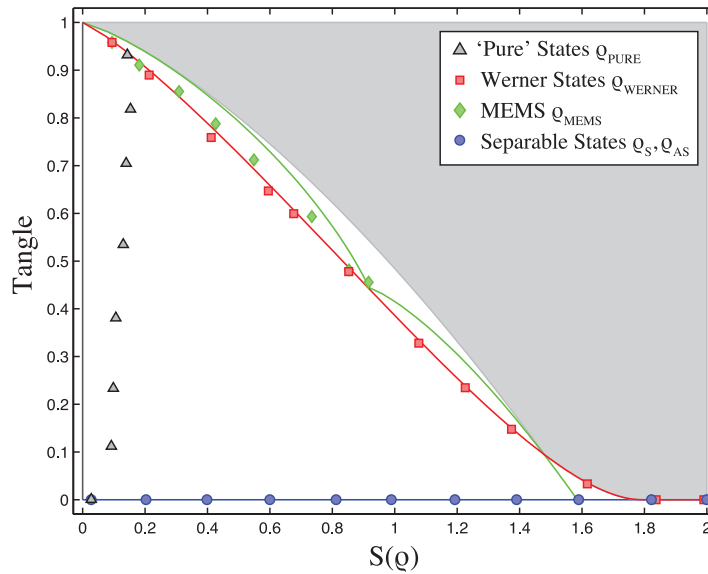

Figure 1. The tangle–von Neumann-entropy plane, showing the 48 experimentally created two-photon states. Error bars are smaller than the symbol size. The lines are predictions for the ideal states, table 1. Data points for ρ_{AS} and ρ_S overlap. The shaded area represents unphysical states, and the states on the boundary are rank-3 MEMS [17].

entropy, which are otherwise not directly accessible experimentally. The 48 created states are shown in figure 1: for each, we calculate $I_a = I(\rho_a)$ and $I_b = I(\rho_b)$ to obtain $I_{\text{local}} = I_a + I_b$ and $I_{\text{total}} = 2 - S(\rho_{ab})$, respectively. For the correlation information I_{corr} , we subtract I_{local} from I_{total} .

Information complementarity for our experimental states ρ_{PURE} is shown in figure 3. When \mathcal{T} vanishes, the total information is stored exclusively in the individual subsystems. As the entanglement increases, so does I_{corr} , and as \mathcal{T} approaches 1, I_{local} goes to zero. This phenomenon is strictly quantum—a *pure classical* state cannot contain any mutual information. More importantly, for pure quantum states, I_{corr} corresponds to the *entanglement of formation* [29]. This means that information complementarity reduces to a sum of entanglement and local information, each of which can be measured independently, and thus (3) has the same form as (2), the only difference being that (3) is symmetric with respect to the subsystems, i.e. it accounts for the local properties of both subsystems a and b . Because any pure entangled two-qubit state can be obtained from the Schmidt form ρ_{pure} via local operations, the data in figure 3 represent a conclusive test of (3) and (2) for *all* pure two-qubit states (see also the appendix).

For mixed states, I_{corr} is no longer exclusively identified with entanglement [30, 31]. The Werner states, ρ_{WERNER} , for example, are a statistical mixture of a maximally entangled state and white noise. The individual qubits in this state are always fully mixed, $I_{\text{local}} = 0$, and their entire information content is stored in I_{corr} , as one can see in figure 4(a). As is well known, Werner states are separable for a high noise admixture ($\mathcal{T} = 0$ for $S(\rho_{\text{WERNER}}) > 1.8$, figure 1) but their I_{corr} does not vanish correspondingly, emphasizing that it does not measure entanglement in this case.

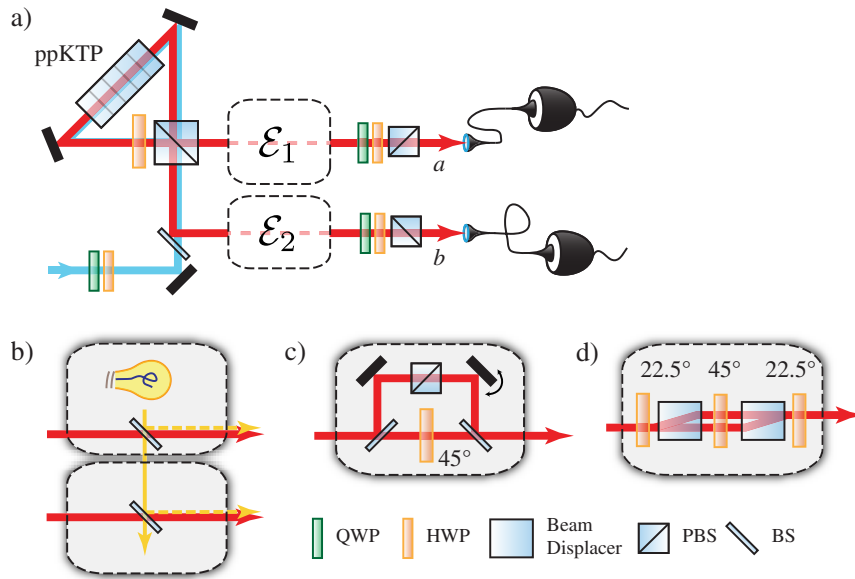

Figure 2. Experimental scheme. (a) A source [26, 27] creates pure two-photon states with a tunable degree of entanglement. Channels \mathcal{E}_1 and \mathcal{E}_2 introduce mixing before state tomography is performed. (b) For the creation of ρ_{WERNER} and ρ_{S} (table 1), an incandescent light source with tunable intensity is reflected into the setup. The increase in accidental coincidence detections resembles white noise. (c) For MEMS state creation [25], a beamsplitter (BS) is introduced. The transmitted beam polarization is rotated by 90° and the reflected beam is polarized at a polarizing beam splitter (PBS) before the beams are recombined incoherently. Two steering mirrors control the splitting ratio between the two beams and thus parameter p in ρ_{MEMS} (table 1). This technique allows the creation of ρ_{MEMS} in the range of $0 \leq S(\rho) \lesssim 0.92$. The remaining states can be covered by dephasing the second photon once $p = 2/3$ is reached. In practice, the initial tangle in our experiment was too low to create states with significantly higher entanglement than the corresponding ρ_{WERNER} . (d) Dephasing channel for the creation of ρ_{AS} . Jamin–Lebedeff interferometers introduce optical path delays between the orthogonal polarization components of incoming photons in a given basis. Two interferometers are used to first individually decohere photon 1 from zero to fully mixed and then photon 2.

By comparing the Werner to MEMS states, we show that I_{corr} is not even a monotonic function of entanglement. Out of the several different existing classes [17] of MEMS, we chose to create rank-2 MEMS, ρ_{MEMS} , using the method from [25], illustrated in figure 2(b). As one can see in figure 4(b), the local information contents of these states are nonzero. For any value of S , even though they are more entangled (cf figure 1), I_{corr} for ρ_{MEMS} is *lower* than that for the corresponding ρ_{WERNER} . In particular, we find that for $I_{\text{total}} = 1.4$ bits the Werner state has more mutual information $I_{\text{corr}} = 1.387 \pm 0.001$ and less tangle $\mathcal{T} = 0.647 \pm 0.004$ than the corresponding MEMS, where $I_{\text{corr}} = 1.315 \pm 0.018$ and $\mathcal{T} = 0.667 \pm 0.007$. The higher entanglement of MEMS states in comparison to Werner states coincides with a relative *decrease of correlations*. In our experiment, this difference is small, due to the difficulty of producing

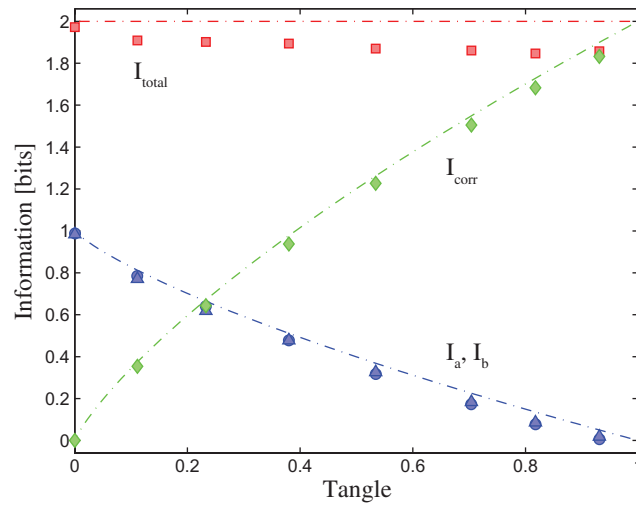

Figure 3. Information complementarity for ‘pure’ states ρ_{PURE} . Ideally, equation (3) is in this case $I_a + I_b + I_{\text{corr}} = 2$. The quantities involved are measured independently; our result therefore represents a genuine test of complementarity. Ideal pure states are represented by lines. Our data ($\bullet = I_a$, $\blacktriangle = I_b$, $\blacklozenge = I_{\text{corr}}$, $\blacksquare = I_{\text{total}}$) fall short of these due to experimental imperfections: mostly non-ideal optical components and detector dark counts. Error bars are smaller than the symbol size.

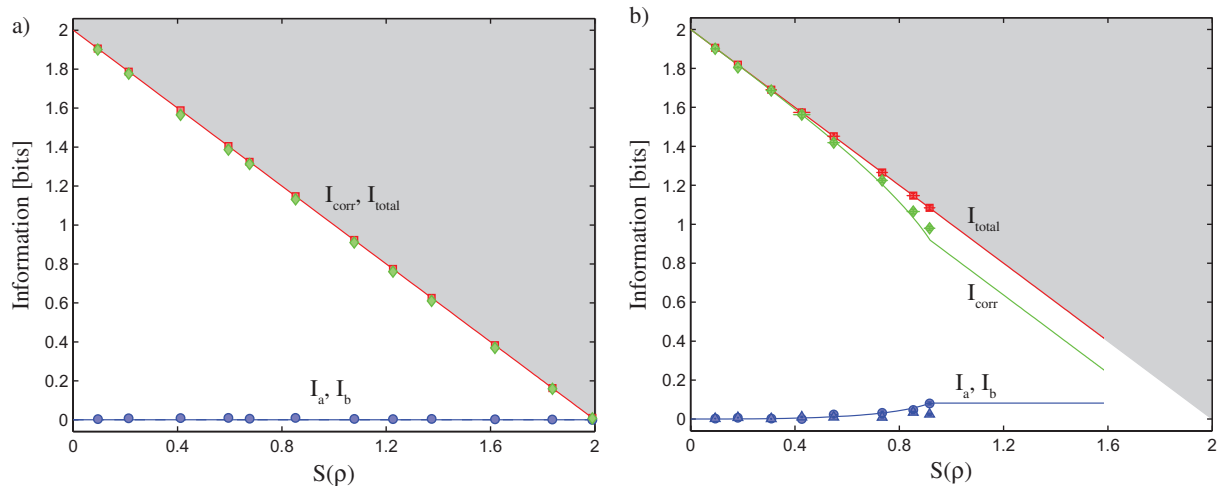

Figure 4. Information content in (a) the Werner states ρ_{WERNER} and (b) maximally-entangled mixed states ρ_{MEMS} . (a) The entire information content of ρ_{WERNER} is stored in correlations. (b) Even though ρ_{MEMS} have more entanglement (cf figure 1) than ρ_{WERNER} , they have less I_{corr} (\blacklozenge). Solid lines represent ideal states. Error bars for (a) are smaller than the symbol size ($\blacksquare = I_{\text{total}}$, $\blacktriangle = I_a$, $\bullet = I_b$). For (b), they were obtained by assuming Poissonian count statistics.

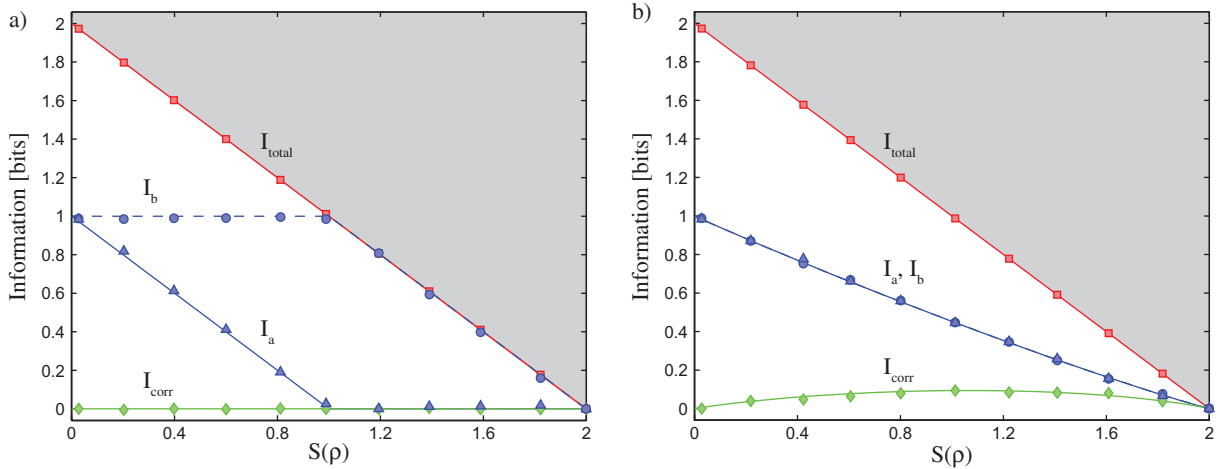

Figure 5. Information content in (a) asymmetrically, ρ_{AS} , and (b) symmetrically mixed product states, ρ_S . Both states are separable but ρ_S has nonzero correlations I_{corr} . Lines represent the information content of the ideal states; data points are measured values ($\blacksquare = I_{total}$, $\blacklozenge = I_{corr}$, $\blacktriangle = I_a$, $\bullet = I_b$). All error bars are smaller than the symbol size.

high-quality MEMS. There are, however, states for which the effect is far more pronounced, as we show in appendix B. Such states indicate that complementarity relations such as (2) miss some quantities as both local information and entanglement can grow from one state to another.

Our third example shows that aspects of complementarity between local information and correlations are already present in classical states. We consider two classes of mixed separable states, ρ_{AS} and ρ_S (table 1). The former, ρ_{AS} , represents two individually dephased photons. The latter, ρ_S , consists of a product state with a white noise admixture; see figure 2(d) for the experimental details.

In figure 5(a), one can clearly see that product states with individually added noise, ρ_{AS} , do not contain any correlations, $I_{corr} = 0$. In contrast, states with globally added white noise, ρ_S , contain $I_{corr} = 0.094 \pm 0.023$ bits of mutual information at $I_{total} = 1$ bit, whereas I_{local} is reduced accordingly (figure 5(b)).

In conclusion, we performed a test of information complementarity and traditional complementarity for pure two-qubit states and showed that the two approaches can be reconciled in this case. We measured the information distribution in mixed quantum systems, which allowed us to demonstrate that correlations are not a monotonic function of entanglement. This suggests what is missing in traditional complementarity relations such as (2). These relations are not exact, because they do not take into account any other correlations than those due to entanglement. It remains an open question whether a traditional complementarity relation—based on directly observable quantities—can be formulated which includes classical correlations and quantum discord [30, 31], dissonance [32] or other recently proposed correlation measures [33, 34]. An interesting alternative might be to tie wave–particle duality to the Bell inequality violations, as shown in [35] for Werner states.

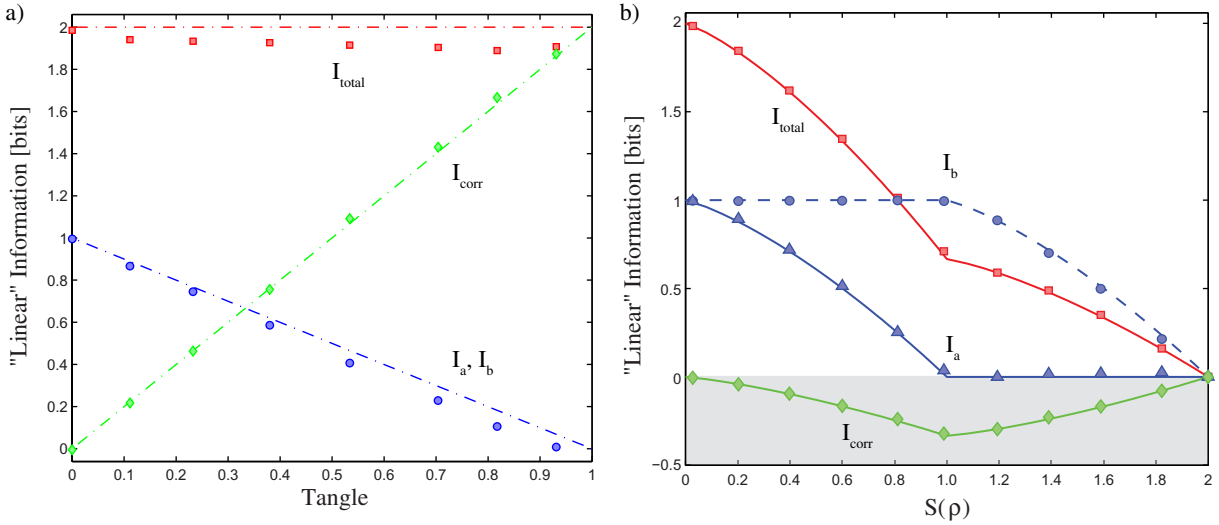

Figure A.1. Experimental verification of traditional complementarity relation (2) of the main text. (a) For ρ_{PURE} , there is a linear relation between the information in correlations I_{corr} (\blacklozenge) and tangle. (b) For the mixed state ρ_{AS} , I_{corr} assumes negative values (shaded area) for the full mixing range. ($\blacksquare = I_{\text{total}}$, $\blacktriangle = I_a$, $\bullet = I_b$; error bars are smaller than the symbols).

Acknowledgments

We thank R Łapkiewicz, B P Lanyon, Č Brukner and A Zeilinger for valuable input. This work was supported by the ARC Centres of Excellence, Discovery and Federation Fellowships programs and an IARPA-funded US Army Research Office contract. TP acknowledges support from the National Research Foundation and the Ministry of Education, Singapore.

Appendix A. Complementarity from linear entropy

Here we show that for pure states, the complementarity relation (2) of the main text is a special case of information complementarity

$$I_{\text{local}} + I_{\text{corr}} = I_{\text{total}}. \quad (\text{A.1})$$

For the moment, we quantify information using the measure of [20], which is based on linear entropy [17]. The information content of the state of a single two-level system (qubit) is given by the length of the corresponding Bloch vector, and a pure state of N qubits carries N bits of information. For pure states of two qubits, $I_{\text{total}} = 2$. Since the information is invariant under unitary operations, we write a pure two-qubit state in its Schmidt basis $|\psi\rangle = \cos\alpha|00\rangle + \sin\alpha|11\rangle$. Therefore, subsystems a and b are described by the same density operator and the local information reads $I_{\text{local}} = I_a + I_b = 2\cos^2\alpha = 2(\mathcal{V}_i^2 + \mathcal{P}_i^2)$, where $i = a$ or b and \mathcal{V}_i (\mathcal{P}_i) denotes visibility (predictability) for the respective subsystem. Information in correlations is now given by $I_{\text{corr}} = 2 - 2\cos^2\alpha = 2\sin^2\alpha = 2\mathcal{C}^2$, where \mathcal{C} is the concurrence, defined by $\mathcal{C} = |\langle\psi|\tilde{\psi}\rangle|$ with $|\tilde{\psi}\rangle \equiv \sigma_y \otimes \sigma_y |\psi^*\rangle = -\cos\alpha|11\rangle - \sin\alpha|00\rangle$, because $|\psi^*\rangle$ is the complex conjugate of $|\psi\rangle$ written in the standard basis. Putting these findings into (A.1) gives relation (2) of the main text. Figure A.1(a) presents an experimental verification of this

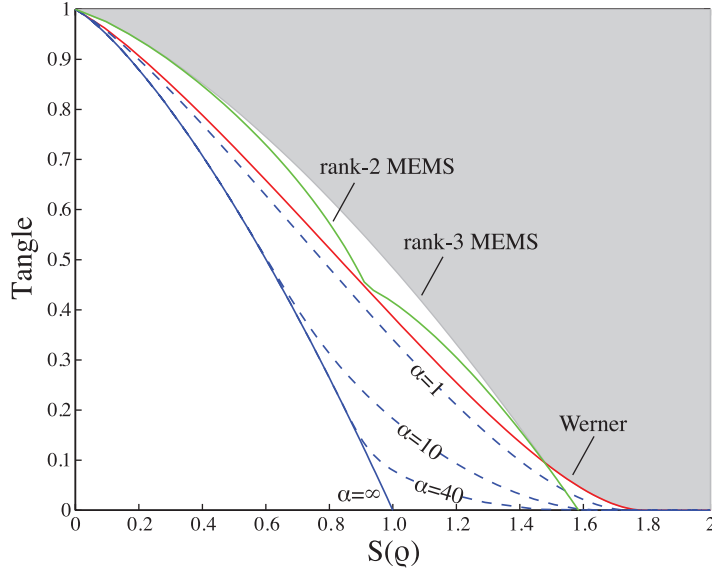

Figure A.2. Theory plot for states $\rho_D(\gamma)$ with $0 < \gamma < 1$ in comparison with the Werner states ρ_{WERNER} (red line) and MEMS ρ_{MEMS} (green line). The blue dashed lines represent states dephased in two conjugate bases, with different weightings γ and γ^α . The information content of dephased states is the same as that for ρ_{WERNER} and is larger than that for the MEMS states even for entanglement arbitrarily close to zero.

traditional complementarity relation. Note that information complementarity based on linear entropy has been discussed, for example, in [36].

Figure A.1(b) shows that the information measure based on the linear entropy is nonadditive in the sense that I_{corr} is negative for the product state ρ_{AS} , defined in the main text. This is the reason why we to stick to von Neumann entropy instead of linear entropy in the main text.

Appendix B. Doubly dephased states

Here we present a class of weakly entangled states of two 2-level systems, for which I_{corr} is consistently higher than that for the MEMS states. Consider the states

$$\rho_D(\gamma) = \frac{1}{4}(I \otimes I - (1 - \gamma)\sigma_x \otimes \sigma_x - (1 - \gamma)(1 - \gamma^\alpha)\sigma_y \otimes \sigma_y - (1 - \gamma^\alpha)\sigma_z \otimes \sigma_z), \quad (\text{B.1})$$

which can be viewed as a result of dephasing of the Bell singlet state $|\psi^-\rangle$ in the local bases of Pauli operators σ_z and σ_x . The dephasing in the z -basis has strength γ and that in the x -basis has strength γ^α . Just like the Werner states, $\rho_D(\gamma)$ has information *only* in correlations, i.e. $I_{\text{local}} = 0$, cf figure 4(a). We plot the entanglement (tangle) of these states for various α in figure A.2. Since MEMS states with the same amount of total information have nonvanishing I_{local} , they contain less information in correlations than does $\rho_D(\gamma)$, even at $S(\rho) > 1$ and large α , in which case the entanglement of the dephased states is close to zero [37]. In the most extreme case, at $S(\rho) = 1$, the state ρ_D has zero tangle but retains 1 bit of (classical) correlations I_{corr} . The rank-3 MEMS (the boundary of the shaded area in figure 2), in comparison, has a tangle of $\mathcal{T} \sim 0.48$ and $I_{\text{corr}} \sim 0.94$ bit.

References

- [1] Greenberger D M and Yasin A 1988 Simultaneous wave and particle knowledge in a neutron interferometer *Phys. Lett. A* **128** 391–4
- [2] Englert B G 1996 Fringe visibility and which-way information: an inequality *Phys. Rev. Lett.* **77** 2154–7
- [3] Schwindt P D D, Kwiat P G and Englert B G 1999 Quantitative wave–particle duality and nonerasing quantum erasure *Phys. Rev. A* **60** 4285–90
- [4] Chang D I, Khym G L, Kang K, Chung Y, Lee H J, Seo M, Heiblum M, Mahalu D and Umansky V 2008 Quantum mechanical complementarity probed in a closed-loop Aharonov–Bohm interferometer *Nat. Phys.* **4** 205
- [5] Zeilinger A, Gähler R, Shull C G, Treimer W and Mampe W Single- and double-slit diffraction of neutrons *Rev. Mod. Phys.* **60** 1067–73
- [6] Dürr S, Nonn T and Rempe G 1998 Fringe visibility and which-way information in an atom interferometer *Phys. Rev. Lett.* **81** 5705–9
- [7] Gerlich S, Hackermüller L, Hornberger K, Stibor A, Ulbricht H, Gring M, Goldfarb F, Savas S, Müri M, Mayor M and Arndt M 2007 A Kapitza–Dirac–Talbot–Lau interferometer for highly polarizable molecules *Nat. Phys.* **3** 711–5
- [8] Kolesov R, Grotz B, Balasubramanian G, Stohr R J, Nicolet A A L, Hemmer P R, Jelezko F and Wrachtrup J 2009 Wave–particle duality of single surface plasmon polaritons *Nat. Phys.* **5** 470–4
- [9] Hill S and Wootters W K 1997 Entanglement of a pair of quantum bits *Phys. Rev. Lett.* **78** 5022–5
- [10] Jakob M and Bergou J A 2003 Quantitative complementarity relations in bipartite systems arXiv:quant-ph/0302075
- [11] de Melo F, Walborn S P, Bergou J A and Davidovich L 2007 Quantum nondemolition circuit for testing bipartite complementarity *Phys. Rev. Lett.* **98** 250501
- [12] Abouraddy A F, Nasr M B, Saleh B E A, Sergienko A V and Teich M C 2001 Demonstration of the complementarity of one- and two-photon interference *Phys. Rev. A* **63** 63803
- [13] Peng X, Zhu X, Suter D, Du J, Liu M and Gao K 2005 Quantification of complementarity in multiqubit systems *Phys. Rev. A* **72** 052109
- [14] Jaeger G, Horne M A and Shimony A 1993 Complementarity of one-particle and two-particle interference *Phys. Rev. A* **48** 1023–7
- [15] Salles A, de Melo F, Almeida M P, Hor-Meyll M, Walborn S P, Souto P H Ribeiro and Davidovich L 2008 Experimental investigation of the dynamics of entanglement: sudden death, complementarity, and continuous monitoring of the environment *Phys. Rev. A* **78** 22322
- [16] Hiesmayr B and Huber M 2008 *Phys. Rev. A* **78** 12342
- [17] Wei T C, Nemoto K, Goldbart P M, Kwiat P G, Munro W J and Verstraete F 2003 Maximal entanglement versus entropy for mixed quantum states *Phys. Rev. A* **67** 9288
- [18] Landauer R 1996 The physical nature of information *Phys. Lett. A* **217** 188–93
- [19] Zeilinger A 1999 A foundational principle for quantum mechanics *Found. Phys.* **29** 631–43
- [20] Brukner Č and Zeilinger A 1999 Operationally invariant information in quantum measurements *Phys. Rev. Lett.* **83** 3354–7
- [21] Oppenheim J, Horodecki K, Horodecki M, Horodecki P and Horodecki R 2003 Mutually exclusive aspects of information carried by physical systems: complementarity between local and nonlocal information *Phys. Rev. A* **68** 22307
- [22] Cerf N J and Adami C 1997 Negative entropy and information in quantum mechanics *Phys. Rev. Lett.* **79** 5194–7
- [23] Groisman B, Popescu S and Winter A 2005 Quantum, classical, and total amount of correlations in a quantum state *Phys. Rev. A* **72** 32317
- [24] Munro W J, James D F V, White A G and Kwiat P G 2001 Maximizing the entanglement of two mixed qubits *Phys. Rev. A* **64** 030302

- [25] Aiello A, Puentes G, Voigt D and Woerdman J P 2007 Maximally entangled mixed-state generation via local operations *Phys. Rev. A* **75** 062118
- [26] Kim T, Fiorentino M and Wong F N C 2006 Phase-stable source of polarization-entangled photons using a polarization Sagnac interferometer *Phys. Rev. A* **73** 12316
- [27] Fedrizzi A, Herbst T, Poppe A, Jennewein T and Zeilinger A 2007 A wavelength-tunable fiber-coupled source of narrowband entangled photons *Opt. Express* **15** 15377–86
- [28] James D F V, Kwiat P G, Munro W J and White A G 2001 Measurement of qubits *Phys. Rev. A* **64** 52312
- [29] Horodecki M, Horodecki K, Horodecki P, Horodecki R, Oppenheim J, Sen(De) A and Sen U 2003 Local information as a resource in distributed quantum systems *Phys. Rev. Lett.* **90** 100402
- [30] Ollivier H and Zurek W H 2001 Quantum discord: a measure of the quantumness of correlations *Phys. Rev. Lett.* **88** 017901
- [31] Henderson L and Vedral V 2001 Classical, quantum and total correlations *J. Phys. A: Math. Gen.* **34** 6899–05
- [32] Modi K, Paterek T, Son W, Vedral V and Williamson M 2010 Relative entropy of quantum and classical correlations *Phys. Rev. Lett.* **104** 080501
- [33] Luo S 2008 Using measurement-induced disturbance to characterize correlations as classical or quantum *Phys. Rev. A* **77** 022301
- [34] Wu S, Poulsen U V and Mølmer K 2009 Correlations in local measurements on a quantum state, and complementarity as an explanation of nonclassicality *Phys. Rev. A* **80** 32319
- [35] Filip R, Gavenda M, Soubusta J, Černoč A and Dušek M 2004 How quantum correlations enhance prediction of complementary measurements *Phys. Rev. Lett.* **93** 180404
- [36] Cai J-M, Zhou Z-W and Guo G-C 2007 Fidelity, entanglement, and information complementarity relation *Phys. Lett. A* **363** 392–6
- [37] Škerlak B 2009 Information complementarity in bipartite quantum systems *MSc Thesis* ETH Zurich